

**FRONT VIEW**

CALL STATION MODEL:  
VOIP-600E [SHOWN  
FOR ILLUSTRATION ONLY]

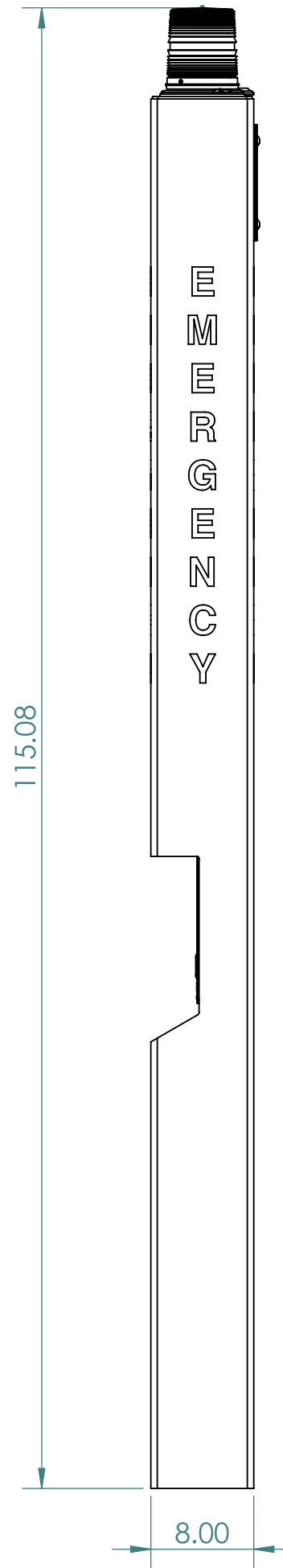

**SIDE VIEW**

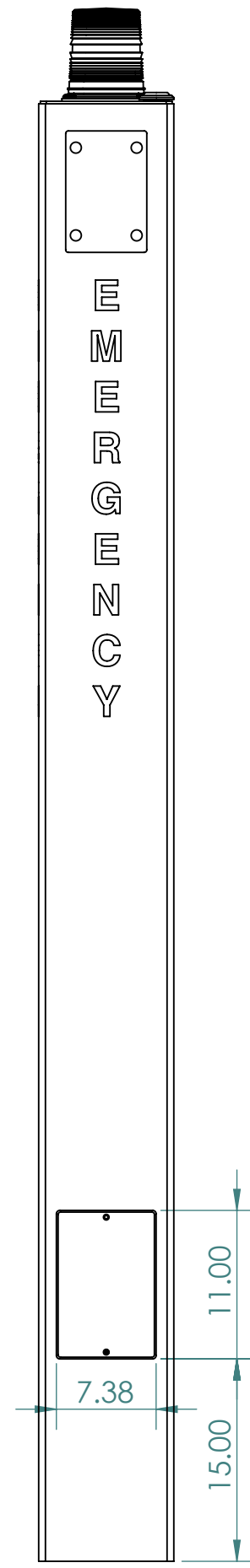

**REAR VIEW**

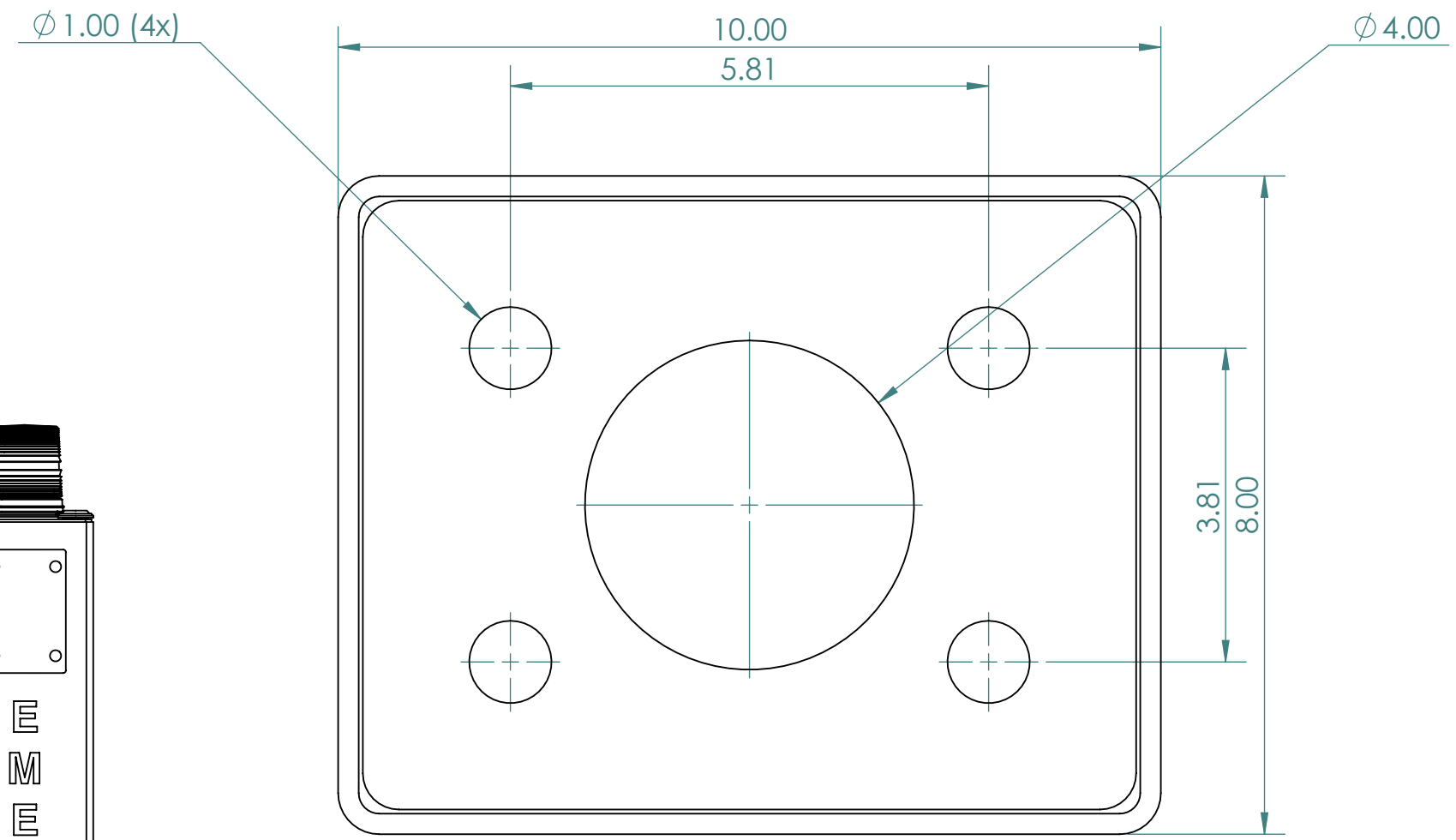

**FOOT PRINT**

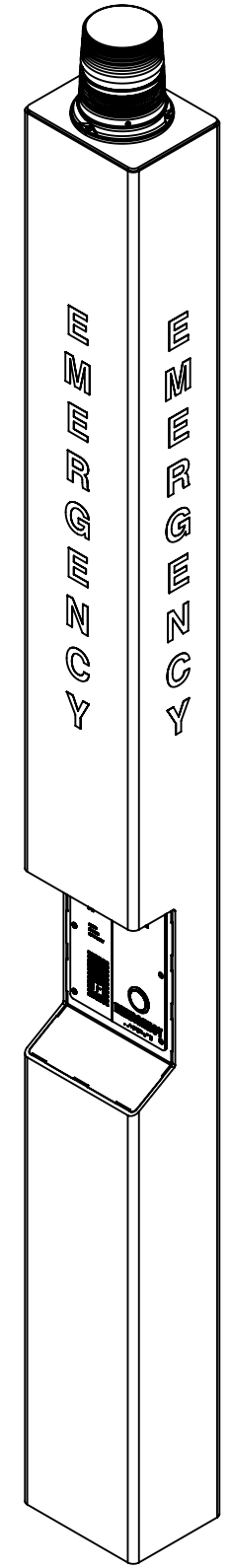

**ISOMETRIC VIEW**

1.0	MARKETING RELEASE	06/17/2020	J MAHETALIA
REV.	DESCRIPTION	DATE	APPROVED
REVISIONS			
	NAME	DATE	
DRAWN	J MAHETALIA	06/17/2020	
CHECKED	K PATEL	06/17/2020	
ENG APPR.			
MFG APPR.			
Q.A.			
COMMENTS:			
<p><b>PROPRIETARY AND CONFIDENTIAL</b> THE INFORMATION CONTAINED IN THIS DRAWING IS THE SOLE PROPERTY OF TALK-A-PHONE, LLC. ANY REPRODUCTION IN PART OR AS A WHOLE WITHOUT THE WRITTEN PERMISSION OF TALK-A-PHONE, LLC IS PROHIBITED.</p>		<p><b>TALKAPHONE</b> TALK-A-PHONE, LLC 7530 N. NATCHEZ AVE. NILES, IL 60714 WWW.TALKAPHONE.COM</p>	
SIZE	PART NO.	ETP-MT	REV
<b>C</b>	DWG. TITLE: ETP-MT SERIES		<b>1.0</b>
SCALE: 1:12		WEIGHT:	SHEET 1 OF 2

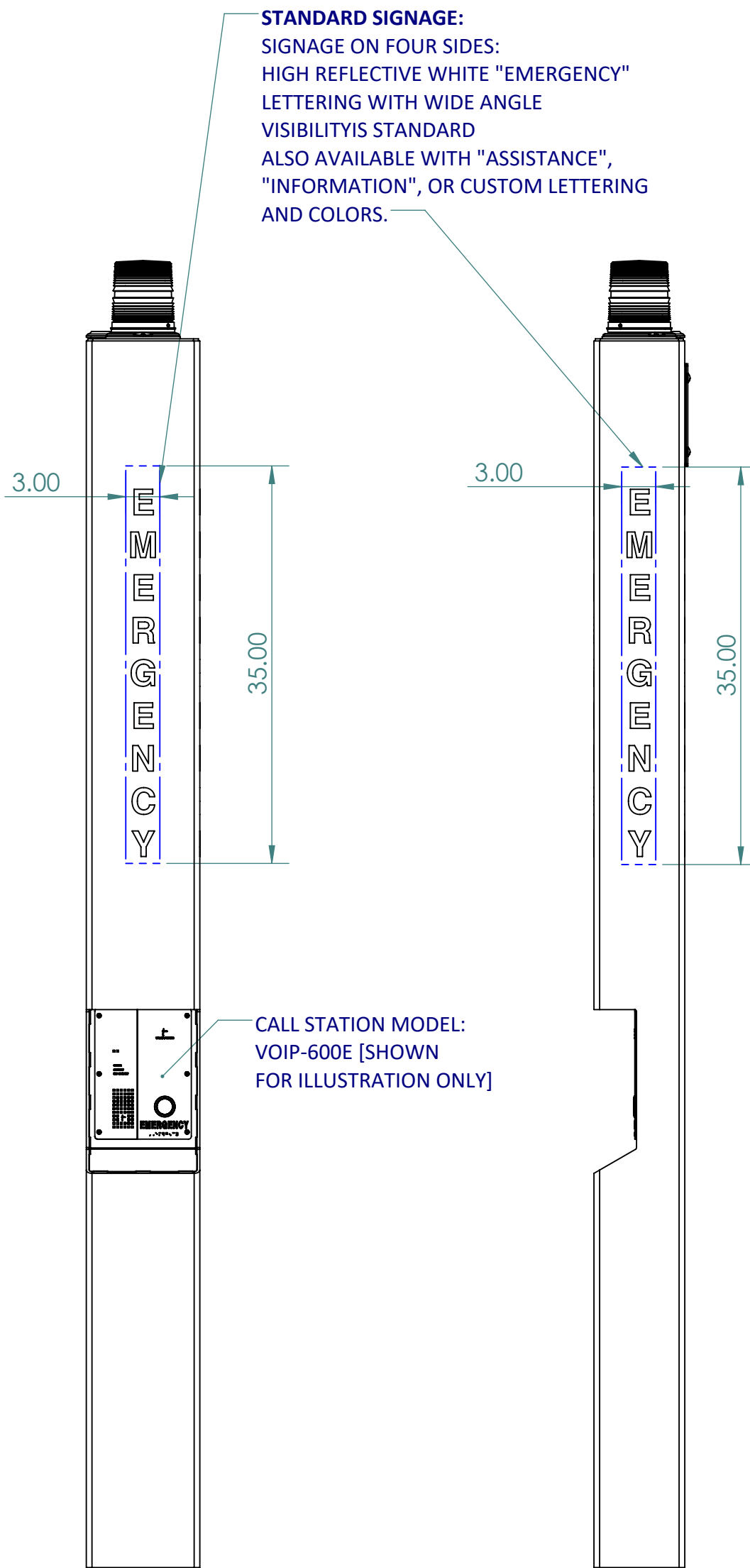

**FRONT VIEW**

**SIDE VIEW**

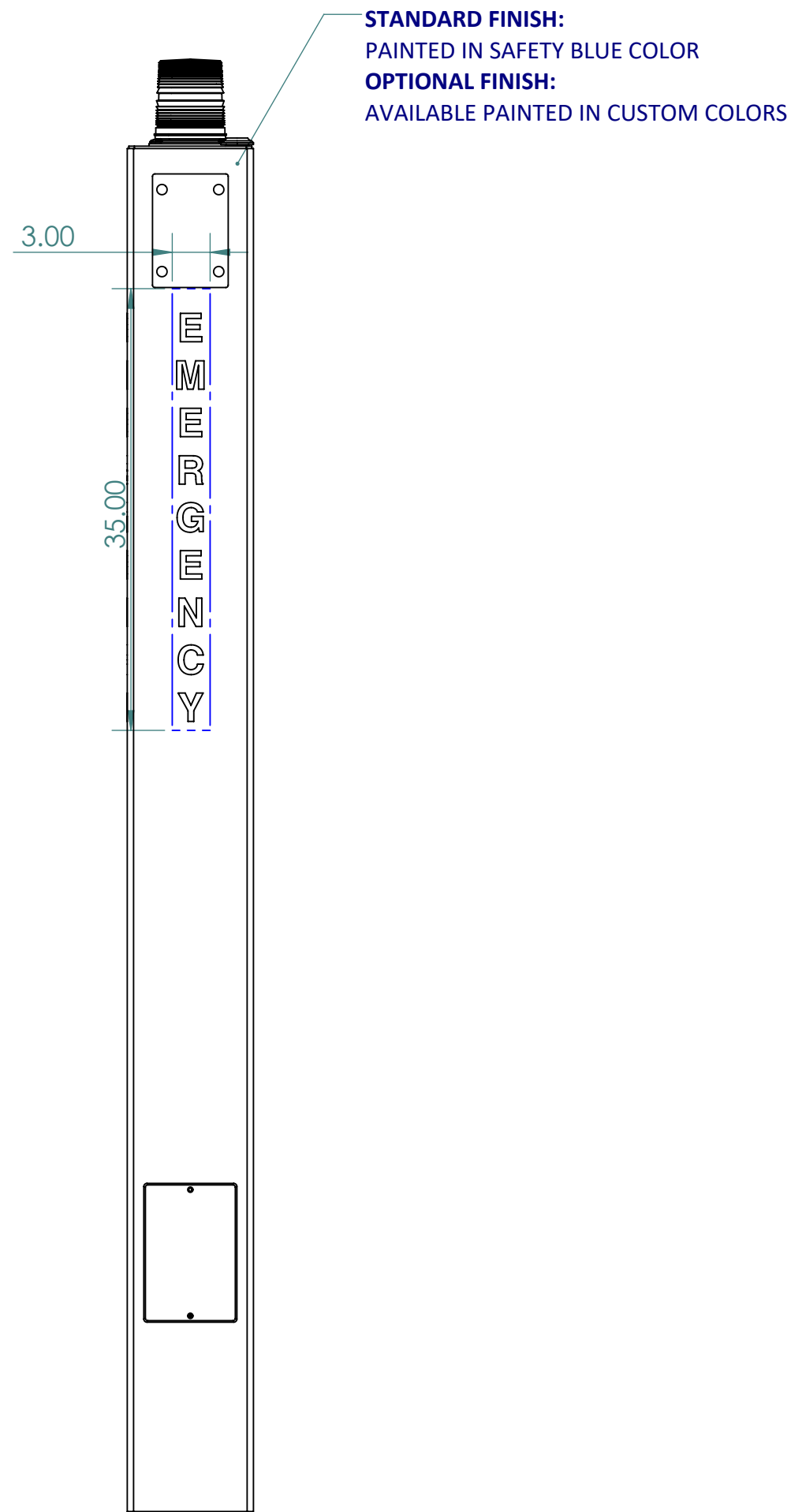

**REAR VIEW**

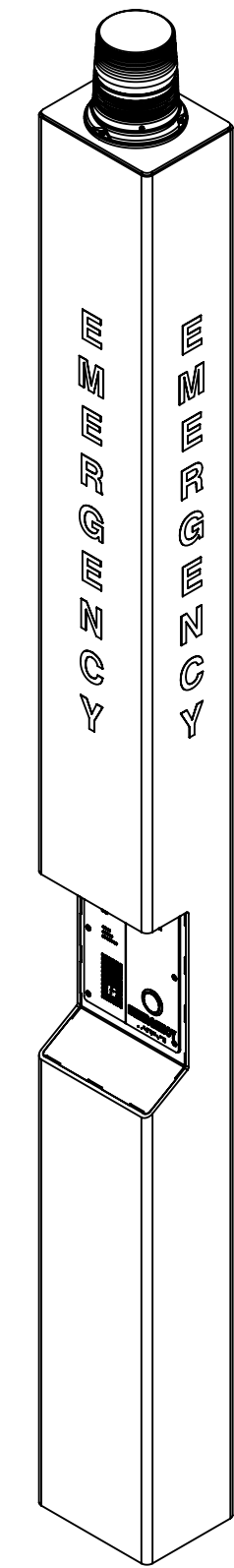

**ISOMETRIC VIEW**

	NAME	DATE
DRAWN	J MAHETALIA	06/17/2020
CHECKED	K PATEL	06/17/2020
ENG APPR.		
MFG APPR.		
Q.A.		

**TALKAPHONE**  
TALK-A-PHONE, LLC  
7530 N. NATCHEZ AVE. NILES, IL 60714  
WWW.TALKAPHONE.COM

**FINISH**

**PROPRIETARY AND CONFIDENTIAL**  
THE INFORMATION CONTAINED IN THIS  
DRAWING IS THE SOLE PROPERTY OF  
TALK-A-PHONE, LLC. ANY  
REPRODUCTION IN PART OR AS A WHOLE  
WITHOUT THE WRITTEN PERMISSION OF  
TALK-A-PHONE, LLC IS PROHIBITED.

DWG. NO.	SIZE	PART NO.	ETP-MT	REV
	<b>C</b>			<b>1.0</b>
	SCALE: 1:12	WEIGHT:		SHEET 2 OF 2